

Technical features of accessories

Roller for the side marking of flat bar
25mm or 1", 30mm or 1" 1/4, 40mm or 1" 1/2 y 50mm or 2"

Ref. 140-11-01-00028

Elements identification

Roller assembling

Roller assembling for 25mm or 1" handrail Roller

assembling for 30mm or 1" 1/4 handrail Roller

assembling for 40mm or 1" 1/2 handrail Roller

assembling for 50mm or 2" handrail

Elements identification

Sectioned rollers for handrail embossing have been designed to work on different handrail sizes with one only set of rollers.

IMPORTANT: In order to achieve a correct use of the machine, it is remarkably essential to place all elements so the total length of the set always remains 80mm.



HAZARD: Never surpass 80mm as maximum length

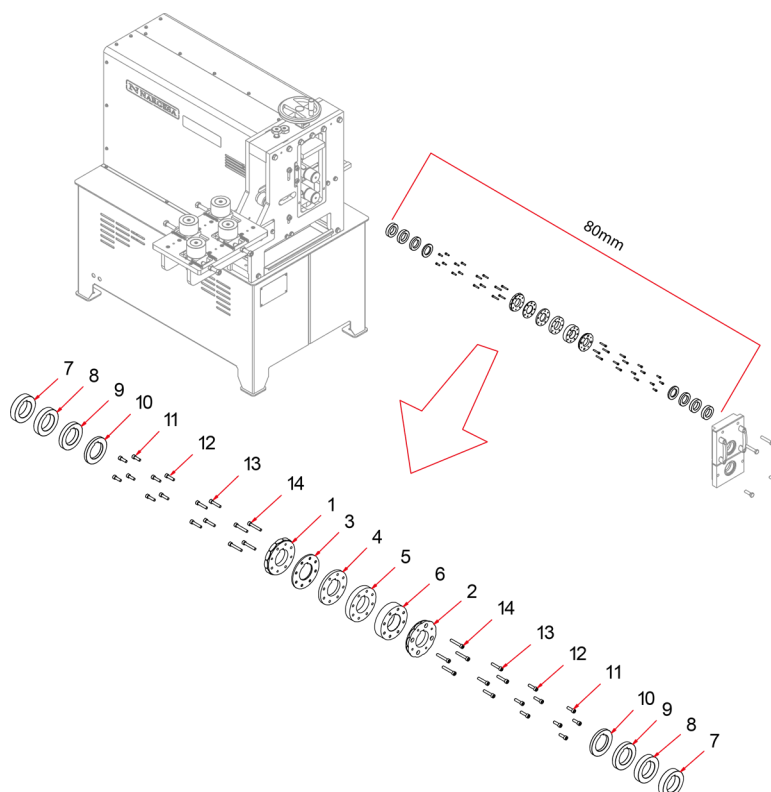

1	125-11-01-00054	LATERAL INNER ROLLER	1
2	125-11-01-00055	LATERAL OUTER ROLLER	1
3	125-11-01-00056	SECTIONED HANDRAIL SPACER 25-1"	1
4	125-11-01-00058	SECTIONED HANDRAIL SPACER 30-1"-1/4	1
5	125-11-01-00060	SECTIONED HANDRAIL SPACER 40-1"-1/2	1
6	125-11-01-00062	SECTIONED HANDRAIL SPACER 50-2"	1
7	125-11-01-00057	SPACER 22.5mm	2
8	125-11-01-00059	SPACER 20mm	2
9	125-11-01-00061	SPACER 15mm	2
10	125-11-01-00063	SPACER 10 mm	2
11	020-D912-M8X25	ALLEN SCREW DIN 912 M8 x25	8
12	020-D912-M8X30	ALLEN SCREW DIN 912 M8X30	8
13	020-D912-M8X40	ALLEN SCREW DIN 912 M8X40	8
14	020-D912-M8X50	ALLEN SCREW DIN 912 M8X50	8

Rollers assembling

We'll use the different rollers sections depending on the size of the handrail to be embossed. Then we'll detail every element used for each handrail size, always including sections 1 and 2 to these sets, which are the ones to perform the embossing operation as such.

Rollers assembling for 25mm or 1" handrail

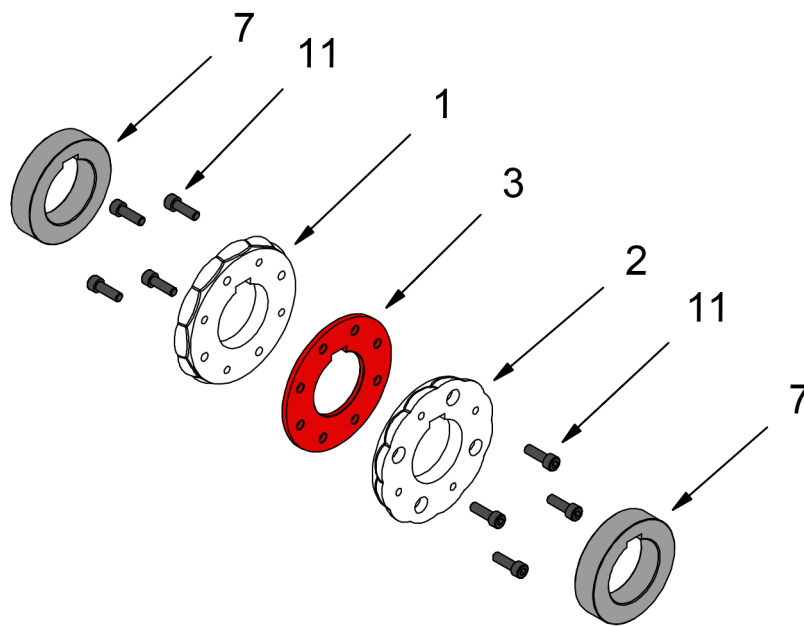

	INTERIOR	3	125-11-01-00056	SECTIONED HANDRAIL SPACER 25-1"
	EXTERIOR	7	125-11-01-00057	SPACER 22.5mm
	TORNILLOS	11	020-D912-M8X25	ALLEN SCREW DIN 912 M8 x25
		1	125-11-01-00054	LATERAL INNER ROLLER
		2	125-11-01-00055	LATERAL OUTER ROLLER

We will use the different sections of the rollers depending on the handrail size that we are going to emboss. To assemble the **roller of 25mm or 1"** we will proceed as follows:

1. We put into order the different sections

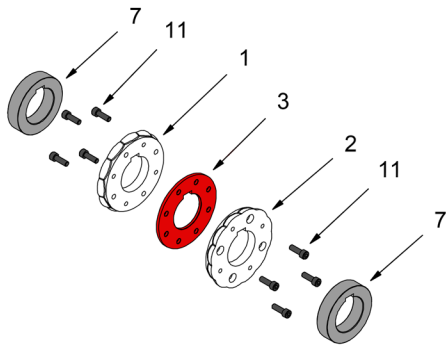

2. We do a pre-assembly, without tightening the bolts, paying special attention in aligning the slots for the pin.

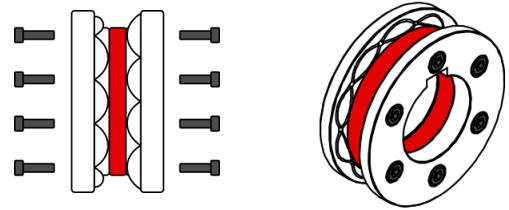

3. Next we place the outer spacer 7 on the upper machine shaft.

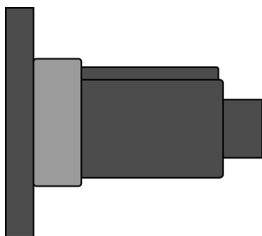

4. Place the pre-mounted roller on the upper axis and tighten the bolts with the Allen key.

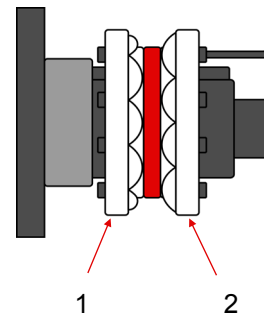

5. We remove the roller from the shaft and we rotate it so that the front part is positioned behind and then we put it in again.

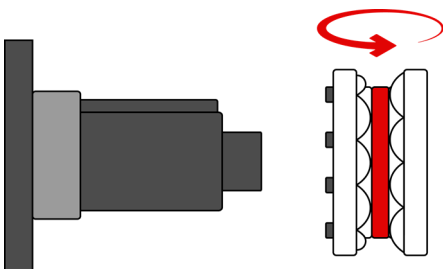

6. Tighten the bolts with the Allen key.

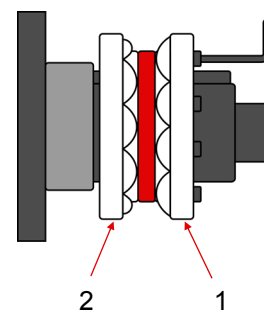

7. We remove the roller from the shaft and we rotate it so that the front part is positioned behind and then we put it in again.

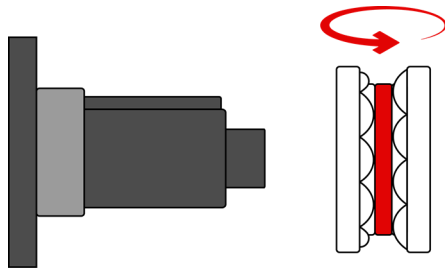

8. Next we place the outer spacer 7 on the upper machine shaft.

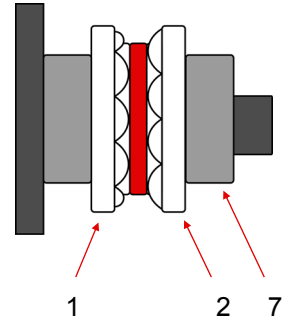

9. Close the roller compartment with the outer cover.

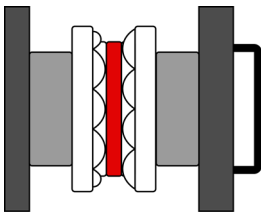

We will use the different sections of the rollers depending on the handrail size that we are going to emboss. To assemble the **roller of 30mm or 1" 1/4** we will proceed as follows:

1. We put into order the different sections

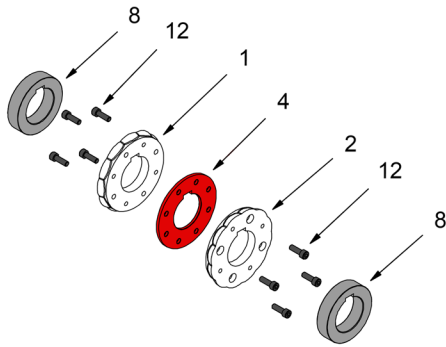

2. We do a pre-assembly, without tightening the bolts, paying special attention in aligning the slots for the pin.

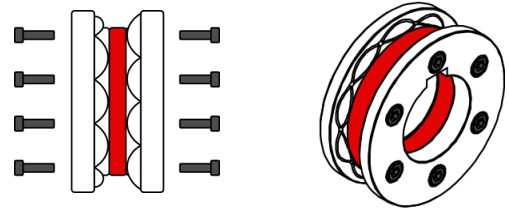

3. Next we place the outer spacer 8 on the upper machine shaft.

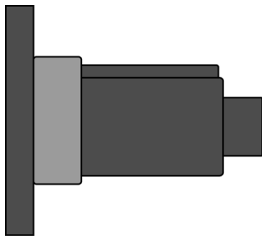

4. Place the pre-mounted roller on the upper axis and tighten the bolts with the Allen key.

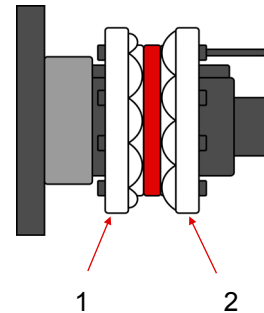

5. We remove the roller from the shaft and we rotate it so that the front part is positioned behind and then we put it in again.

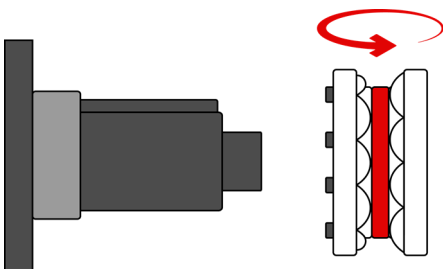

6. Tighten the bolts with the Allen key.

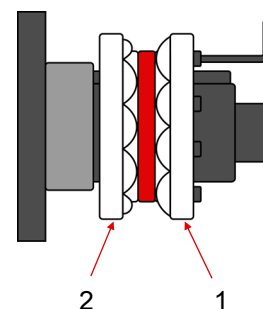

7. We remove the roller from the shaft and we rotate it so that the front part is positioned behind and then we put it in again.

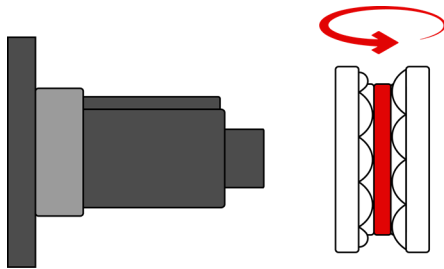

8. Next we place the outer spacer 8 on the upper machine shaft.

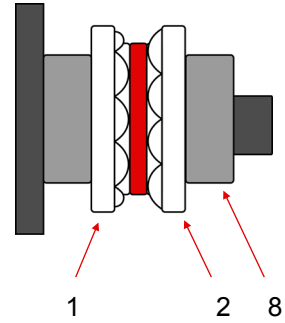

9. Close the roller compartment with the outer cover.

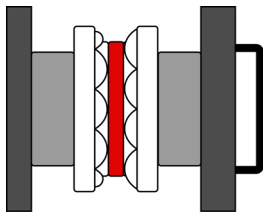

Rollers assembling for 40mm o 1" 1/2 handrail

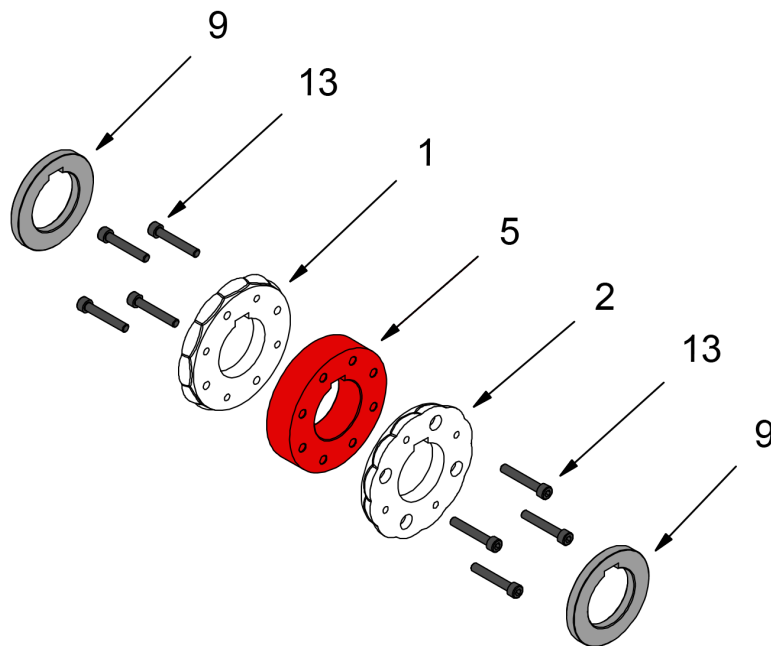

	INTERIOR	5	125-11-01-00060	SEPARADOR PASAMANO 40-1"-1/2
	EXTERIOR	9	125-11-01-00061	Separador 15mm
	TORNILLOS	13	020-D912-M8X40	TORNILLO ALLEN DIN 912 M8X40
		1	125-11-01-00054	DISCO INTERIOR
		2	125-11-01-00055	DISCO EXTERIOR

We will use the different sections of the rollers depending on the handrail size that we are going to emboss. To assemble the roller of 40mm or 1" 1/2 we will proceed as follows:

1. We put into order the different sections

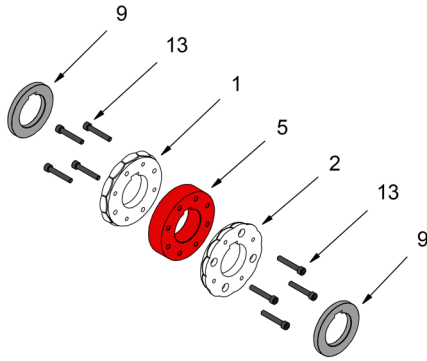

2. We do a pre-assembly, without tightening the bolts, paying special attention in aligning the slots for the pin.

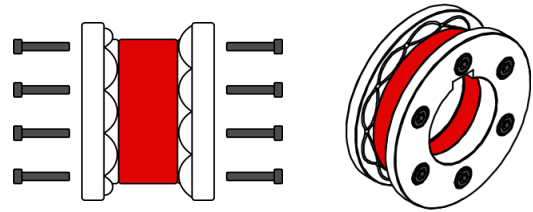

3. Next we place the outer spacer 9 on the upper machine shaft.

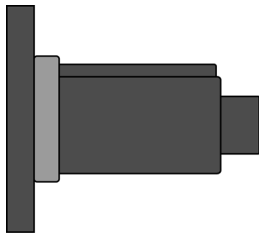

4. Place the pre-mounted roller on the upper axis and tighten the bolts with the Allen key.

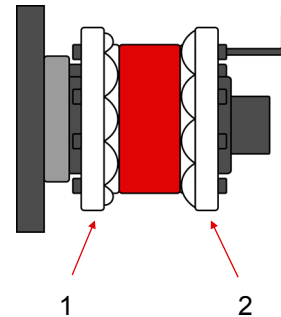

5. We remove the roller from the shaft and we rotate it so that the front part is positioned behind and then we put it in again.

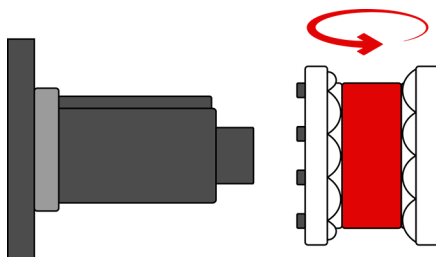

6. Tighten the bolts with the Allen key.

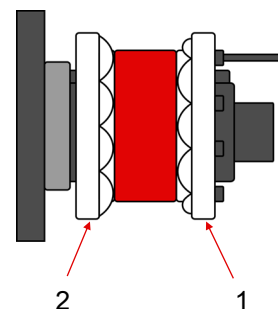

7. We remove the roller from the shaft and we rotate it so that the front part is positioned behind and then we put it in again.

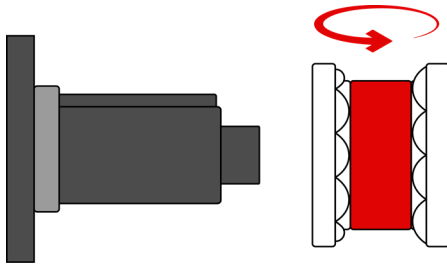

8. Next we place the outer spacer 9 on the upper machine shaft.

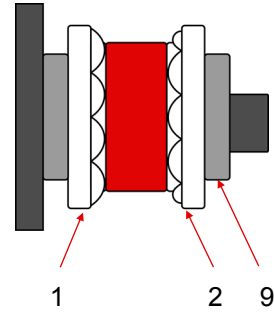

9. Close the roller compartment with the outer cover.

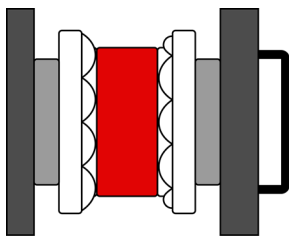

Rollers assembling for 50mm o 2" handrail

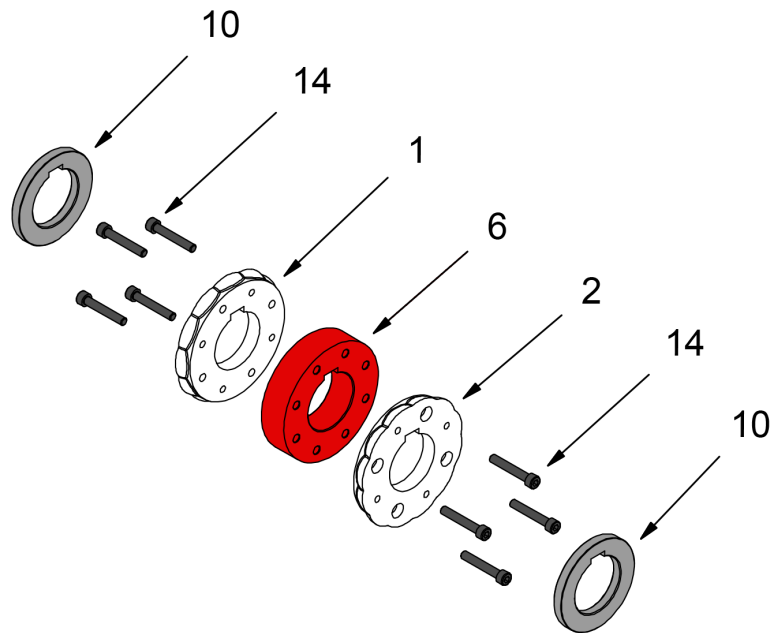

	INTERIOR	6	125-11-01-00062	SECTIONED HANDRAIL SPACER 50-2"
	EXTERIOR	10	125-11-01-00063	SPACER 10 mm
	TORNILLOS	14	020-D912-M8X50	ALLEN SCREW DIN 912 M8X50
		1	125-11-01-00054	LATERAL INNER ROLLER
		2	125-11-01-00055	LATERAL OUTER ROLLER

We will use the different sections of the rollers depending on the handrail size that we are going to emboss. To assemble the **roller of 50mm or 2"** we will proceed as follows:

1. We put into order the different sections

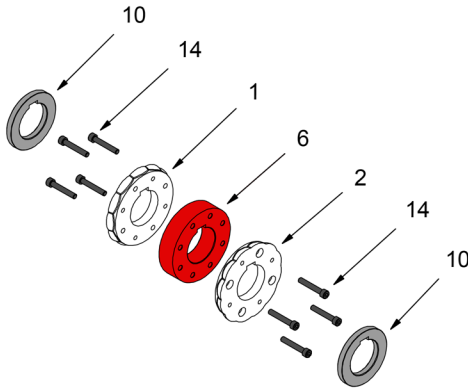

2. We do a pre-assembly, without tightening the bolts, paying special attention in aligning the slots for the pin.

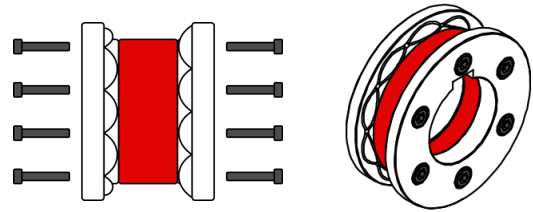

3. Next we place the outer spacer 10 on the upper machine shaft.

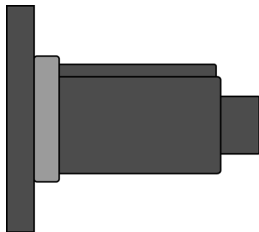

4. Place the pre-mounted roller on the upper axis and tighten the bolts with the Allen key.

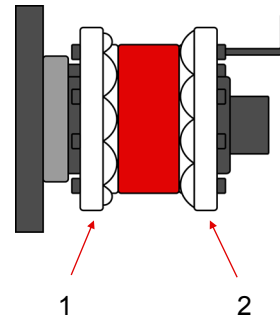

5. We remove the roller from the shaft and we rotate it so that the front part is positioned behind and then we put it in again.

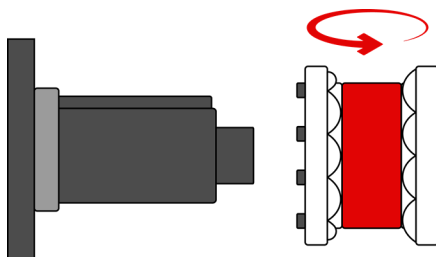

6. Tighten the bolts with the Allen key.

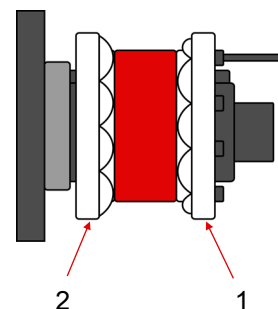

7. We remove the roller from the shaft and we rotate it so that the front part is positioned behind and then we put it in again.

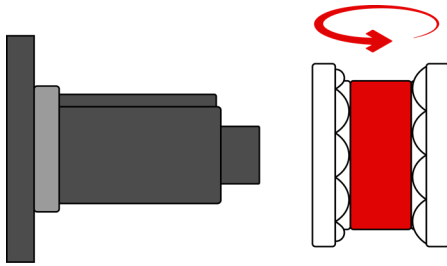

8. Next we place the outer spacer 10 on the upper machine shaft.

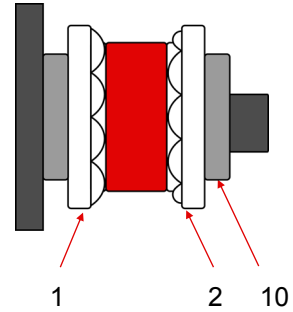

9. Close the roller compartment with the outer cover.

